

MaxMotion

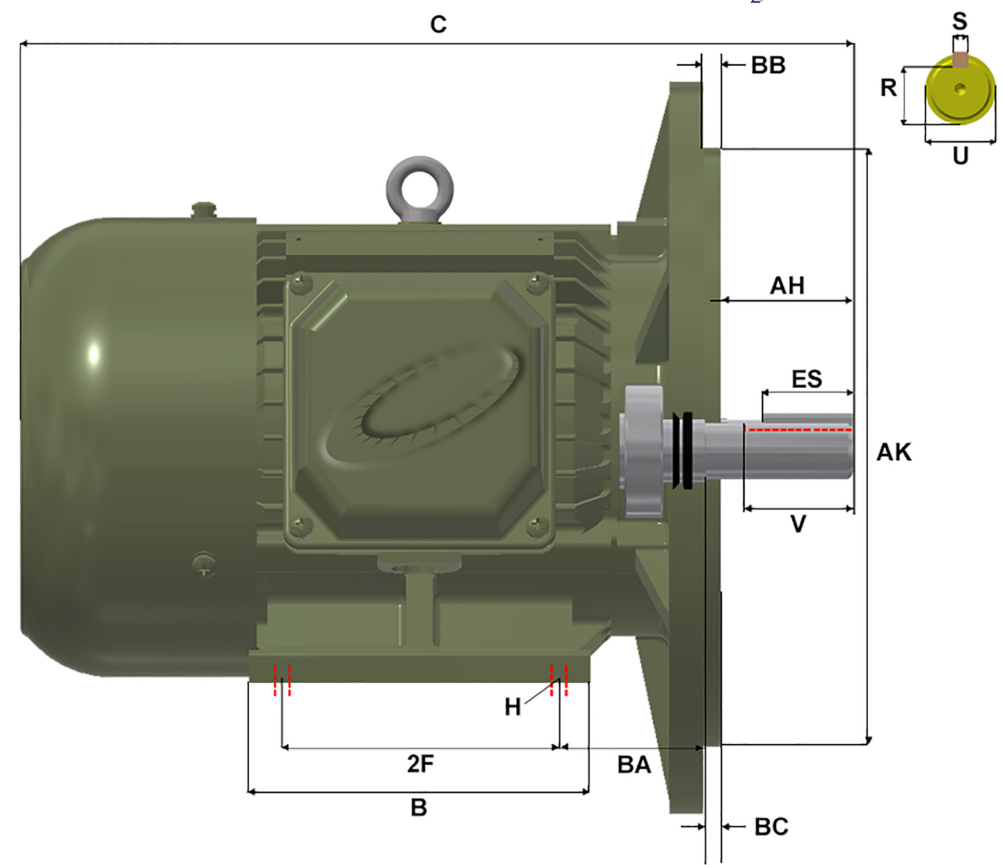
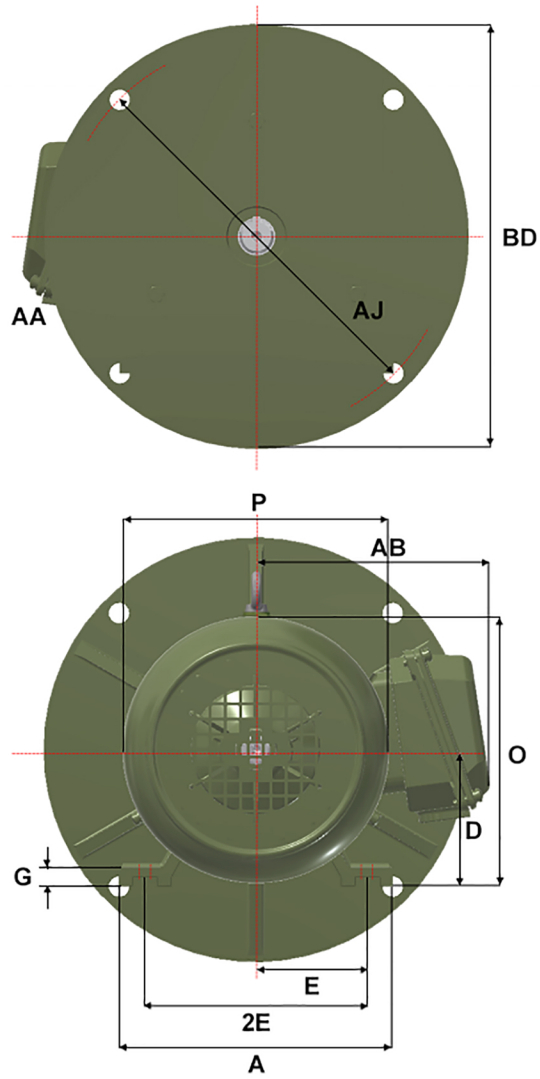

Version: 2WTI		Revised: 08-10-2019		HP	RPM	FRAME	ENCLOSURE	MPP/MQP-24D					
Customer is responsible in determining that MEP product will fit/perform suitably in the intended application				5	900	254TD	TEFC						
A	B	C	D	E	2E	2F	G	H	O	P	R	S	
13.00	12.20	23.20	6.25	5.00	10.00	8.25	0.70	4 * 0.53	13.00	12.40	1.416	0.375	
T	U	V	AA	AB	AH	AJ	AK	BA	BB	BC	BD	ES	
2.20	1.625	3.75	1-1/4 NPT	10.10	4.00	12.50	11.00	4.75	0.25	0.00	14.00	2.91	